

MMDF1N05E, MVDF1N05E

Power MOSFET

2 A, 50 V, N-Channel SO-8, Dual

These miniature surface mount MOSFETs feature ultra low $R_{DS(on)}$ and true logic level performance. They are capable of withstanding high energy in the avalanche and commutation modes and the drain-to-source diode has a low reverse recovery time. These devices are designed for use in low voltage, high speed switching applications where power efficiency is important. Typical applications are dc-dc converters, and power management in portable and battery powered products such as computers, printers, cellular and cordless phones. They can also be used for low voltage motor controls in mass storage products such as disk drives and tape drives. The avalanche energy is specified to eliminate the guesswork in designs where inductive loads are switched and offer additional safety margin against unexpected voltage transients.

Features

- Ultra Low $R_{DS(on)}$ Provides Higher Efficiency and Extends Battery Life
- Logic Level Gate Drive – Can Be Driven by Logic ICs
- Miniature SO-8 Surface Mount Package – Saves Board Space
- Diode Is Characterized for Use In Bridge Circuits
- Diode Exhibits High Speed
- Avalanche Energy Specified
- Mounting Information for SO-8 Package Provided
- I_{DSS} Specified at Elevated Temperature
- This is a Pb-Free Device
- MVDF Prefix for Automotive and Other Applications Requiring Unique Site and Control Change Requirements; AEC-Q101 Qualified and PPAP Capable

MAXIMUM RATINGS ($T_J = 25^\circ\text{C}$ unless otherwise noted)

Rating	Symbol	Value	Unit
Drain-to-Source Voltage	V_{DS}	50	V
Gate-to-Source Voltage – Continuous	V_{GS}	± 20	V
Drain Current – Continuous – Pulsed	I_D I_{DM}	2.0 10	A
Single Pulse Drain-to-Source Avalanche Energy – Starting $T_J = 25^\circ\text{C}$ ($V_{DD} = 25\text{ V}$, $V_{GS} = 10\text{ V}$, $I_L = 2\text{ Apk}$)	E_{AS}	300	mJ
Operating and Storage Temperature Range	T_J , T_{stg}	-55 to 150	$^\circ\text{C}$
Total Power Dissipation @ $T_A = 25^\circ\text{C}$	P_D	2.0	W
Thermal Resistance, Junction-to-Ambient (Note 1)	$R_{\theta JA}$	62.5	$^\circ\text{C/W}$
Maximum Temperature for Soldering, Time in Solder Bath	T_L	260 10	$^\circ\text{C}$ Sec

Stresses exceeding Maximum Ratings may damage the device. Maximum Ratings are stress ratings only. Functional operation above the Recommended Operating Conditions is not implied. Extended exposure to stresses above the Recommended Operating Conditions may affect device reliability.

1. Mounted on 2" square FR4 board (1" sq. 2 oz. Cu 0.06" thick single sided) with one die operating, 10 sec. max.



ON Semiconductor[®]

<http://onsemi.com>

2 AMPERE, 50 VOLTS

$R_{DS(on)} = 300\text{ m}\Omega$

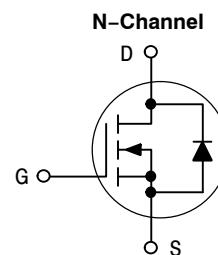

MARKING DIAGRAM



F1N05 = Device Code
 A = Assembly Location
 Y = Year
 WW = Work Week
 ■ = Pb-Free Package

(Note: Microdot may be in either location)

PIN ASSIGNMENT

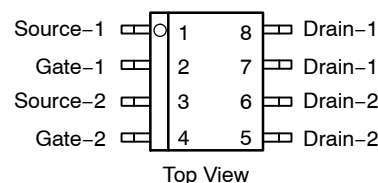

ORDERING INFORMATION

Device	Package	Shipping [†]
MMDF1N05ER2G	SO-8 (Pb-Free)	2,500/Tape & Reel
MVDF1N05ER2G	SO-8 (Pb-Free)	2,500/Tape & Reel

[†]For information on tape and reel specifications, including part orientation and tape sizes, please refer to our Tape and Reel Packaging Specifications Brochure, BRD8011/D.

M MDF1N05E, MVDF1N05E

ELECTRICAL CHARACTERISTICS ($T_A = 25^\circ\text{C}$ unless otherwise noted)

Characteristic	Symbol	Min	Typ	Max	Unit
----------------	--------	-----	-----	-----	------

OFF CHARACTERISTICS

Drain-to-Source Breakdown Voltage ($V_{GS} = 0, I_D = 250 \mu\text{A}$)	$V_{(BR)DSS}$	50	-	-	Vdc
Zero Gate Voltage Drain Current ($V_{DS} = 50 \text{ V}, V_{GS} = 0$)	I_{DSS}	-	-	2	μA_{dc}
Gate-Body Leakage Current ($V_{GS} = 20 \text{ Vdc}, V_{DS} = 0$)	I_{GSS}	-	-	100	nA_{dc}

ON CHARACTERISTICS (Note 2)

Gate Threshold Voltage ($V_{DS} = V_{GS}, I_D = 250 \mu\text{A}_{dc}$)	$V_{GS(th)}$	1.0	-	3.0	Vdc
Drain-to-Source On-Resistance ($V_{GS} = 10 \text{ Vdc}, I_D = 1.5 \text{ A}_{dc}$) ($V_{GS} = 4.5 \text{ Vdc}, I_D = 0.6 \text{ A}_{dc}$)	$R_{DS(on)}$ $R_{DS(on)}$	-	-	0.30 0.50	Ω
Forward Transconductance ($V_{DS} = 15 \text{ V}, I_D = 1.5 \text{ A}$)	g_{FS}	-	1.5	-	mhos

DYNAMIC CHARACTERISTICS

Input Capacitance	$(V_{DS} = 25 \text{ V}, V_{GS} = 0, f = 1.0 \text{ MHz})$	C_{iss}	-	330	-	μF
Output Capacitance		C_{oss}	-	160	-	
Reverse Transfer Capacitance		C_{rss}	-	50	-	

SWITCHING CHARACTERISTICS (Note 3)

Turn-On Delay Time	$(V_{DD} = 10 \text{ V}, I_D = 1.5 \text{ A}, R_L = 10 \Omega, V_G = 10 \text{ V}, R_G = 50 \Omega)$	$t_{d(on)}$	-	-	20	ns
Rise Time		t_r	-	-	30	
Turn-Off Delay Time		$t_{d(off)}$	-	-	40	
Fall Time		t_f	-	-	25	
Total Gate Charge	$(V_{DS} = 10 \text{ V}, I_D = 1.5 \text{ A}, V_{GS} = 10 \text{ V})$	Q_g	-	12.5	-	nC
Gate-Source Charge		Q_{gs}	-	1.9	-	
Gate-Drain Charge		Q_{gd}	-	3.0	-	

SOURCE-DRAIN DIODE CHARACTERISTICS ($T_C = 25^\circ\text{C}$)

Forward Voltage (Note 2)	$(I_S = 1.5 \text{ A}, V_{GS} = 0 \text{ V})$ ($di_S/dt = 100 \text{ A}/\mu\text{s}$)	V_{SD}	-	-	1.6	V
Reverse Recovery Time		t_{rr}	-	45	-	ns

- Pulse Test: Pulse Width $\leq 300 \mu\text{s}$, Duty Cycle $\leq 2.0\%$.
- Switching characteristics are independent of operating junction temperature.

M MDF1N05E, MVDF1N05E

TYPICAL ELECTRICAL CHARACTERISTICS

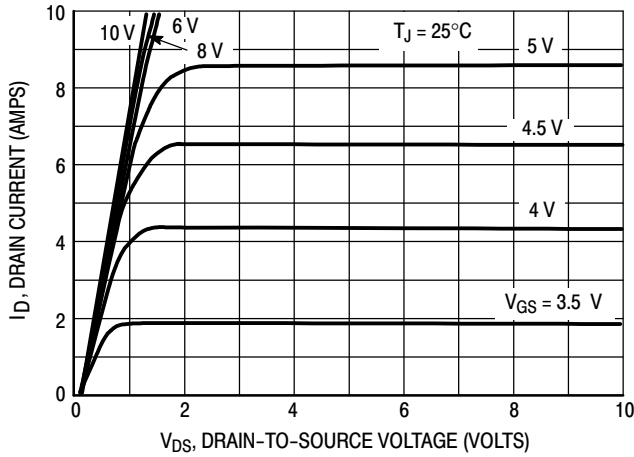

Figure 1. On-Region Characteristics

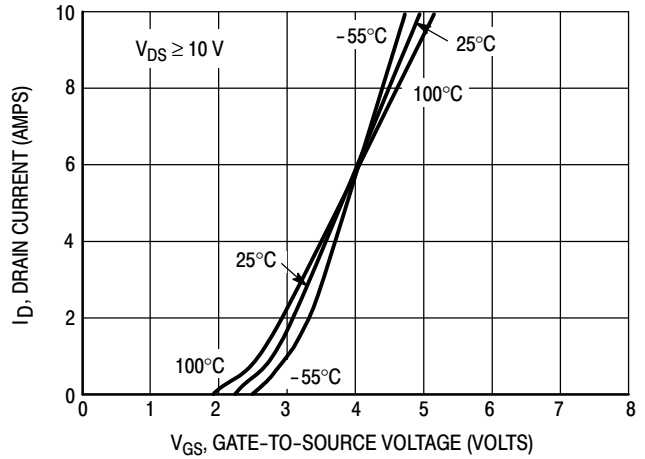

Figure 2. Transfer Characteristics

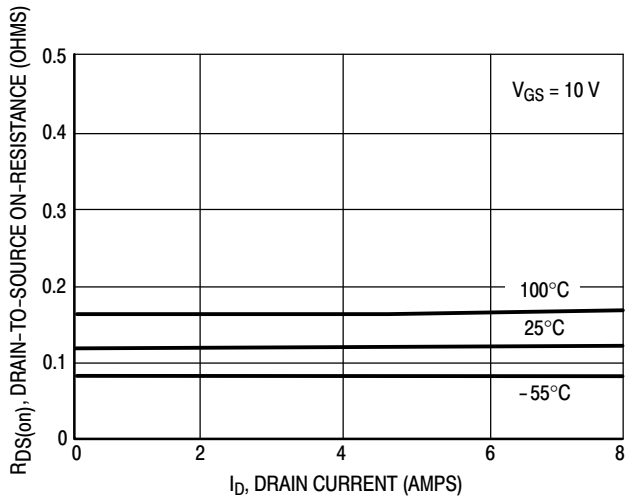

Figure 3. On-Resistance versus Drain Current

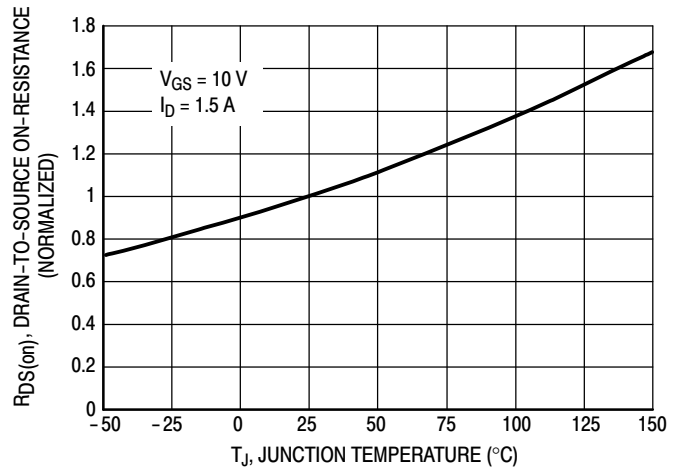

Figure 4. On-Resistance Variation with Temperature

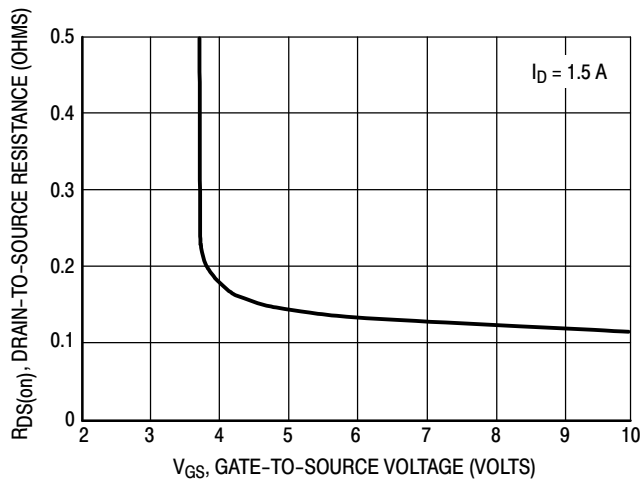

Figure 5. On Resistance versus Gate-to-Source Voltage

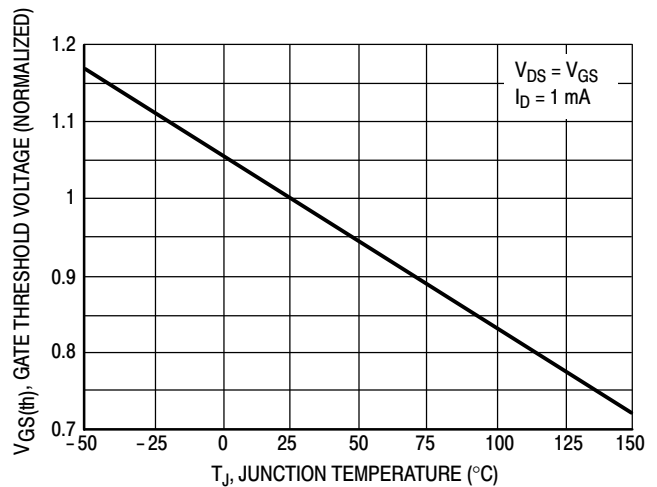

Figure 6. Gate Threshold Voltage Variation with Temperature

MMDF1N05E, MVDF1N05E

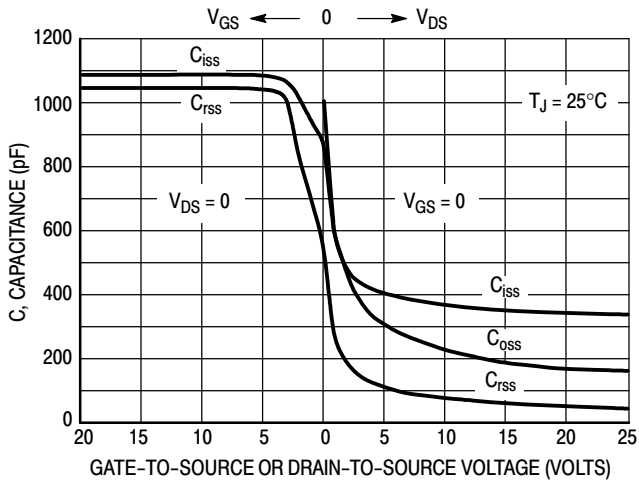

Figure 7. Capacitance Variation

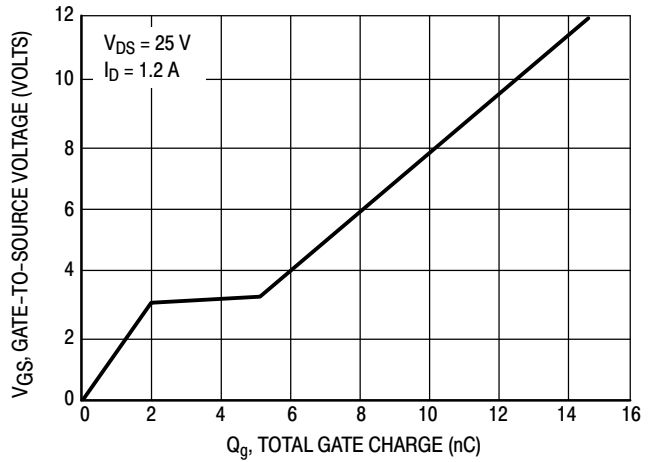

Figure 8. Gate Charge versus Gate-to-Source Voltage

SAFE OPERATING AREA INFORMATION

Forward Biased Safe Operating Area

The FBSOA curves define the maximum drain-to-source voltage and drain current that a device can safely handle when it is forward biased, or when it is on, or being turned on. Because these curves include the limitations of simultaneous high voltage and high current, up to the rating of the device, they are especially useful to designers of linear systems. The curves are based on a case temperature of 25°C and a maximum junction temperature of 150°C. Limitations for repetitive pulses at various case temperatures can be determined by using the thermal response curves. ON Semiconductor Application Note, AN569, "Transient Thermal Resistance – General Data and Its Use" provides detailed instructions.

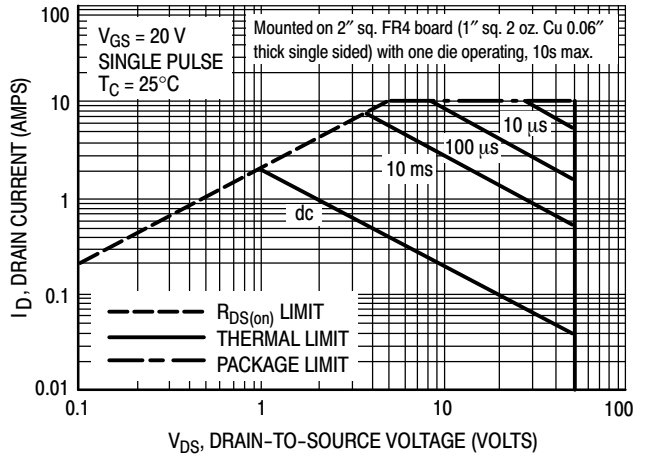

Figure 9. Maximum Rated Forward Biased Safe Operating Area

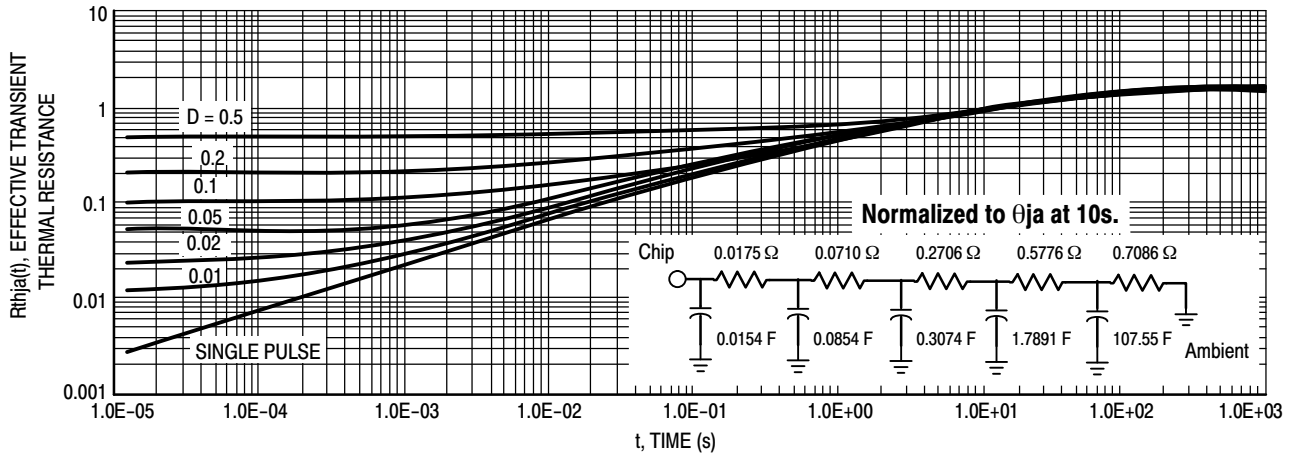
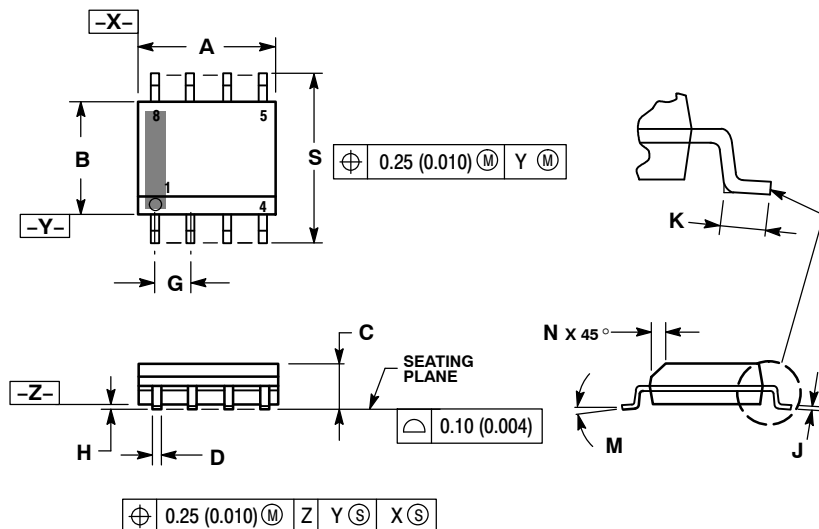

Figure 10. Thermal Response

M MDF1N05E, MVDF1N05E

PACKAGE DIMENSIONS

SOIC-8 CASE 751-07 ISSUE AK



NOTES:

1. DIMENSIONING AND TOLERANCING PER ANSI Y14.5M, 1982.
2. CONTROLLING DIMENSION: MILLIMETER.
3. DIMENSION A AND B DO NOT INCLUDE MOLD PROTRUSION.
4. MAXIMUM MOLD PROTRUSION 0.15 (0.006) PER SIDE.
5. DIMENSION D DOES NOT INCLUDE DAMBAR PROTRUSION. ALLOWABLE DAMBAR PROTRUSION SHALL BE 0.127 (0.005) TOTAL IN EXCESS OF THE D DIMENSION AT MAXIMUM MATERIAL CONDITION.
6. 751-01 THRU 751-06 ARE OBSOLETE. NEW STANDARD IS 751-07.

DIM	MILLIMETERS		INCHES	
	MIN	MAX	MIN	MAX
A	4.80	5.00	0.189	0.197
B	3.80	4.00	0.150	0.157
C	1.35	1.75	0.053	0.069
D	0.33	0.51	0.013	0.020
G	1.27 BSC		0.050 BSC	
H	0.10	0.25	0.004	0.010
J	0.19	0.25	0.007	0.010
K	0.40	1.27	0.016	0.050
M	0°	8°	0°	8°
N	0.25	0.50	0.010	0.020
S	5.80	6.20	0.228	0.244

SOLDERING FOOTPRINT*

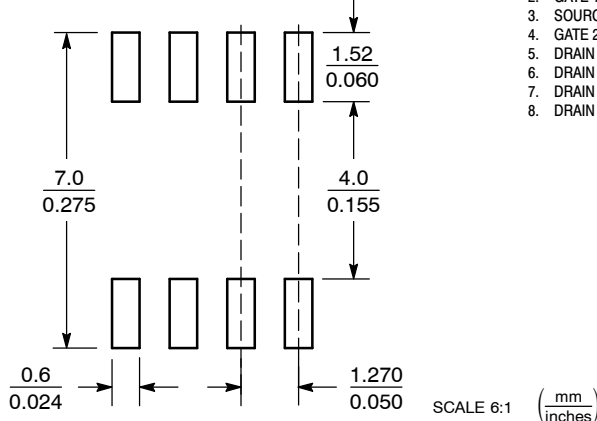

*For additional information on our Pb-Free strategy and soldering details, please download the ON Semiconductor Soldering and Mounting Techniques Reference Manual, SOLDERM/D.

STYLE 11:

1. SOURCE 1
2. GATE 1
3. SOURCE 2
4. GATE 2
5. DRAIN 2
6. DRAIN 2
7. DRAIN 1
8. DRAIN 1

ON Semiconductor and are registered trademarks of Semiconductor Components Industries, LLC (SCILLC). SCILLC reserves the right to make changes without further notice to any products herein. SCILLC makes no warranty, representation or guarantee regarding the suitability of its products for any particular purpose, nor does SCILLC assume any liability arising out of the application or use of any product or circuit, and specifically disclaims any and all liability, including without limitation special, consequential or incidental damages. "Typical" parameters which may be provided in SCILLC data sheets and/or specifications can and do vary in different applications and actual performance may vary over time. All operating parameters, including "Typicals" must be validated for each customer application by customer's technical experts. SCILLC does not convey any license under its patent rights nor the rights of others. SCILLC products are not designed, intended, or authorized for use as components in systems intended for surgical implant into the body, or other applications intended to support or sustain life, or for any other application in which the failure of the SCILLC product could create a situation where personal injury or death may occur. Should Buyer purchase or use SCILLC products for any such unintended or unauthorized application, Buyer shall indemnify and hold SCILLC and its officers, employees, subsidiaries, affiliates, and distributors harmless against all claims, costs, damages, and expenses, and reasonable attorney fees arising out of, directly or indirectly, any claim of personal injury or death associated with such unintended or unauthorized use, even if such claim alleges that SCILLC was negligent regarding the design or manufacture of the part. SCILLC is an Equal Opportunity/Affirmative Action Employer. This literature is subject to all applicable copyright laws and is not for resale in any manner.

PUBLICATION ORDERING INFORMATION

LITERATURE FULFILLMENT:

Literature Distribution Center for ON Semiconductor
P.O. Box 5163, Denver, Colorado 80217 USA
Phone: 303-675-2175 or 800-344-3860 Toll Free USA/Canada
Fax: 303-675-2176 or 800-344-3867 Toll Free USA/Canada
Email: orderlit@onsemi.com

N. American Technical Support: 800-282-9855 Toll Free
USA/Canada
Europe, Middle East and Africa Technical Support:
Phone: 421 33 790 2910
Japan Customer Focus Center
Phone: 81-3-5817-1050

ON Semiconductor Website: www.onsemi.com

Order Literature: <http://www.onsemi.com/orderlit>

For additional information, please contact your local Sales Representative